

Linear Modules

Technical Data – Summary S-Series

		Pneumatic								
		LM 4 S			LM 5 S			LM 6 S		
		S-30	S-60	S-90	S-60	S-90	S-120	S-60	S-120	S-180
Stroke lengths h [mm]:	0-30	●								
	0-60		●		●			●		
	0-90			●		●				
	0-120						●		●	
	0-180									●
Theor. force Fa/Fb [N]: (pneumatic design at 5 bar)	100/86	●	●	●						
	157/131				●	●	●			
	245/206							●	●	●
Max. permissible mass [kg]:	2	●	●	●						
	4				●	●	●			
	6							●	●	●
Cylinder diameter [mm]:	1x16	●	●	●						
	1x20				●	●	●			
	1x25							●	●	●
Air consumption per cycle at 5 bar and nominal stroke [NI]:		0.06	0.12	0.18	0.2	0.3	0.4	0.3	0.6	0.9
Weight [kg]:		0.6	0.8	0.9	1.2	1.4	1.6	2.1	2.6	3.2
Point of application of force for all torques [mm]:	M	65	65	70	70	75	75	105	120	120
Maximum static torques [Nm]:	Ma	10	20	20	25	25	25	60	60	80
	Mb	10	20	20	25	25	25	60	60	80
	Mc	30	30	30	80	80	80	100	100	100
Front stop range of adjustment [mm]:	x2	0-30	0-60	0-90	0-60	0-90	0-120	0-60	0-120	0-180
Rear stop range of adjustment [mm]:	x1	0-30	0-30	0-30	0-40	0-40	0-40	0-30	0-60	0-60
Repeat accuracy [mm]:		±0,01	±0,01	±0,01	±0,01	±0,01	±0,01	±0,01	±0,01	±0,01

This applies to calculations:

* $M_a/M_{a \max} + M_b/M_{b \max} + M_c/M_{c \max} < 1$

* For stresses during the drive of the carriage $M_{\max} = 20\% M_{\max \text{ static}}$

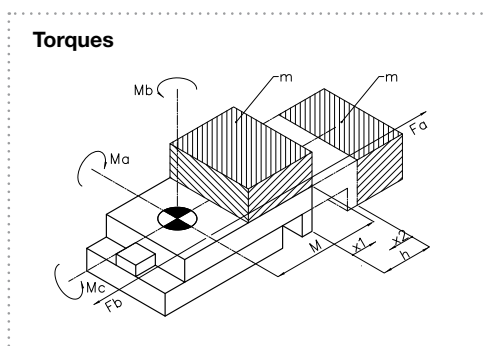

Linear Modules

Load Diagrams

Axial Load

The graph shows the deflection f of the slide under the effect of the force F . The deflection is independent of the stroke.

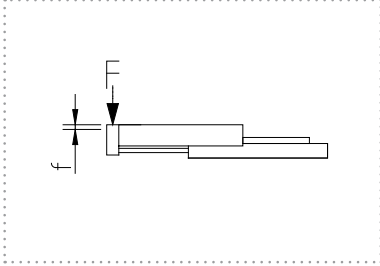

Transverse Load

The graph shows the deflection f of the slide under the effect of the force F . The deflection is independent of the stroke.

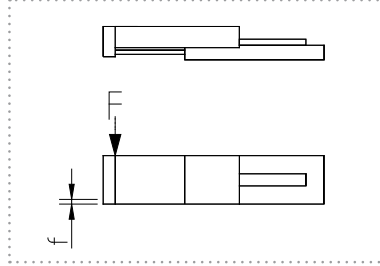

Lateral Load

The graph shows the deflection f of the slide at point A under the effect of the torque. The deflection is independent of the stroke.

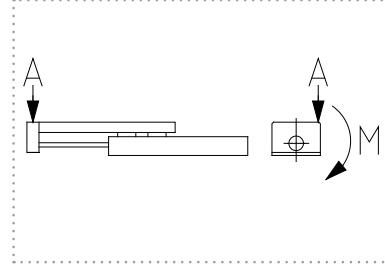

LM 4 S

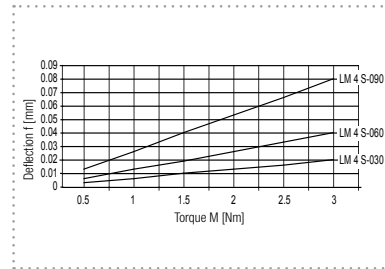
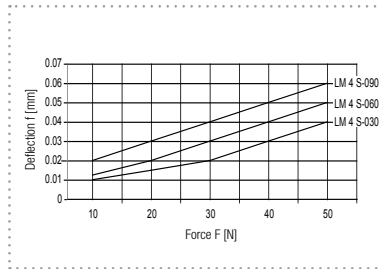
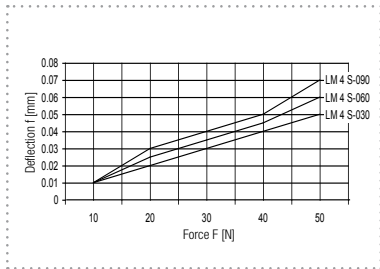

LM 5 S

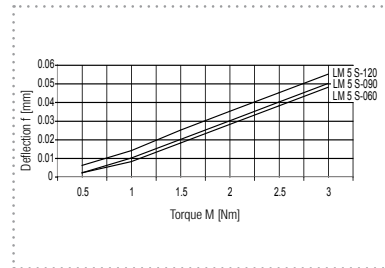
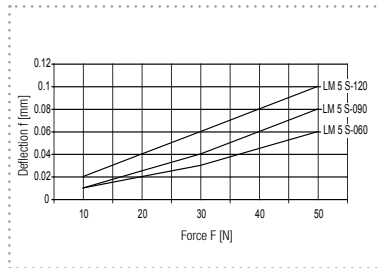
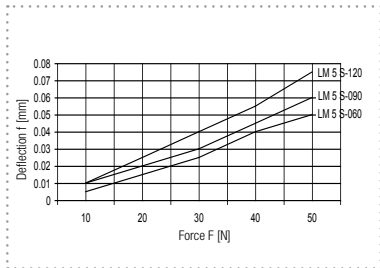

LM 6 S

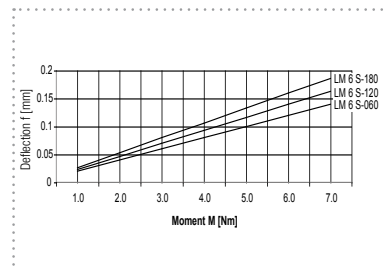
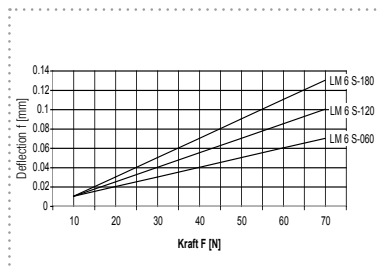
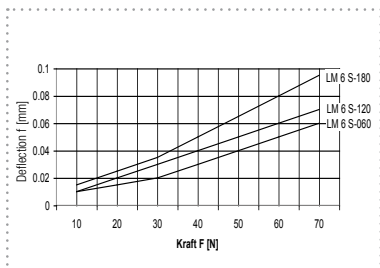

Linear Modules

LM 4 S – Pneumatic Linear Module

LM 4 S



Technical data, stroke-independent

Cylinder diameter	1 x Ø16 mm
Theor. force (at 5 bar)	Fa 100 N Fb 86 N
Max. speed	0,5 m/s
Pneumatic connections	M5
Medium	Compressed-air filtered, oiled or non-oiled
Operating pressure range	3 to 7 bar
Temperature range	0 to +60° C
Repeat accuracy	+/-0.01 mm
Max. permissible mass	2 kg

Technical data, stroke-dependent

See page 36

Permissible travel time t relative to the stroke length and the additional mass m

The travel time t determined from the diagram may not be undershot.

Recommendation: When selecting the module, the travel time t should be assumed as being 20% more.

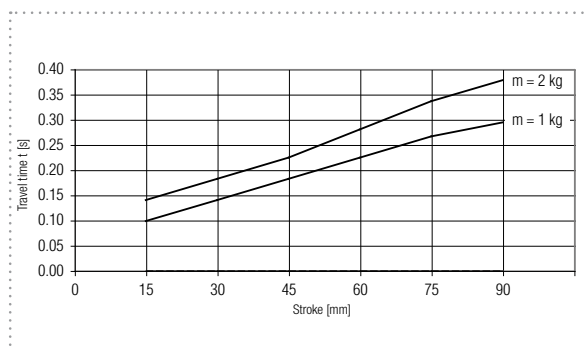

Permissible travel time t = travel time without valve switching time, at nominal pressure 6 bar.

Linear Modules

LM 4 S – Pneumatic Linear Module

Dimensional drawing and pneumatic diagram

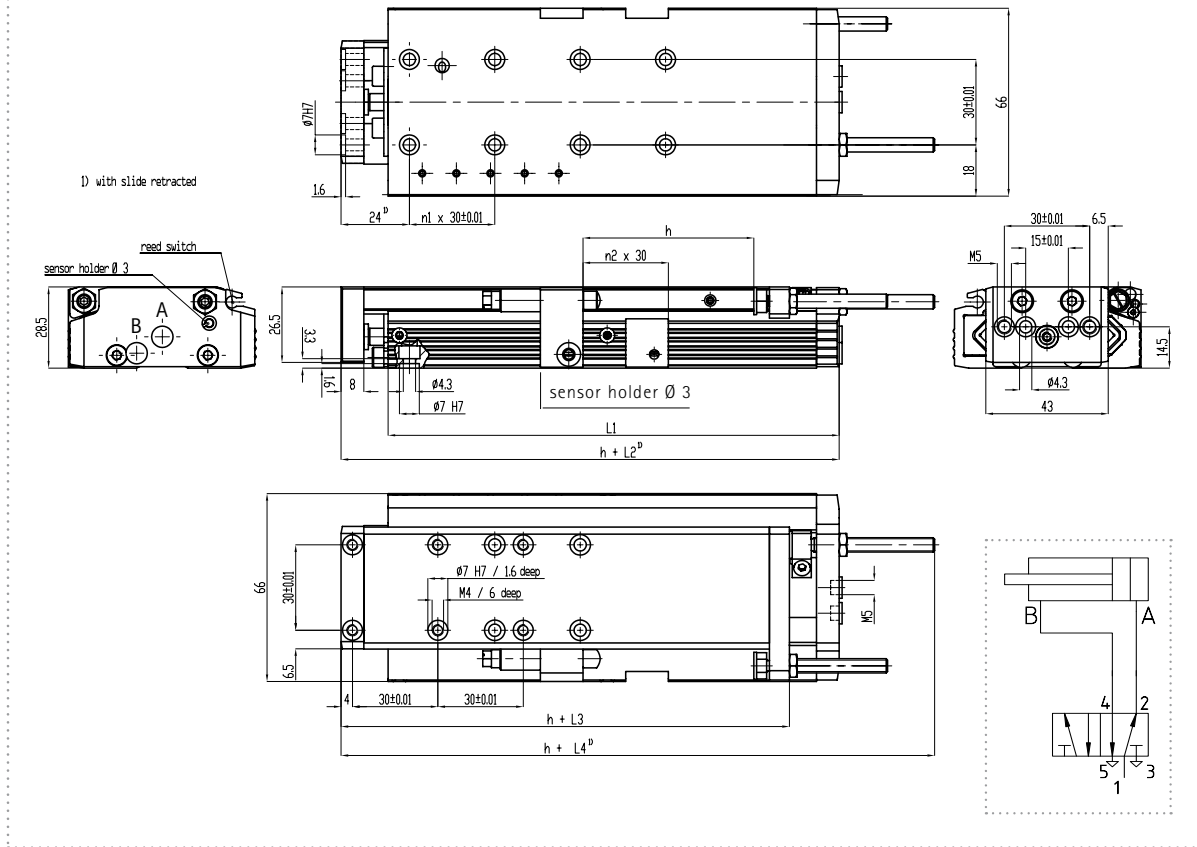

Designation	h	l ₁	l ₂	l ₃	l ₄	n ₁	n ₂
LM 4 S-30	30	107.0	123.5	105.0	156.0	2	0
LM 4 S-60	60	136.5	153.0	134.5	185.5	3	1
LM 4 S-90	90	171.0	187.5	169.0	220.0	4	2

Designation	Order number
LM 4 S-030	302 1626
LM 4 S-060	302 1610
LM 4 S-090	302 1585

Incl. hydraulic shock absorber and
4 Centering ring Ø 7

Accessories	Order number
Centering ring Ø 7	300 1521
Limit switch Ø 3	300 3162
Reed switch	300 1288 for flute
Centering coupling ZK 5/6	300 2478
Shock absorber	300 1386

See chapter Accessories

Overview

Linear Axes
pneum. / electr.

Linear Modules
pneum. / electr.

Linear Modules
with Intermediate
Positions

Rotary Modules

Grippers

Basic Elements

Accessories