

Linear Modules

Technical Data – Summary F-Series

		Pneumatic								
		LM 4 F			LM 5 F			LM 6 F		
		F-30	F-60	F-90	F-60	F-90	F-120	F-60	F-120	F-180
Stroke lengths [mm]: h	0-30	●								
	0-60		●		●			●		
	0-90			●		●				
	0-120						●		●	
	0-180									●
	0-240									
	0-270									
	0-360									
Theor. force Fa/Fb [N]: (pneumatic design at 5 bar)	50/38	●	●	●						
	113/85				●	●	●			
	201/173							●	●	●
	110/110									
	394/346									
Max. permissible mass [kg]:	0,8	●	●	●						
	2,5				●	●	●			
	5							●	●	●
	8									
Cylinder diameter [mm]:	2xØ8	●	●	●						
	2xØ12				●	●	●			
	2xØ16							●	●	●
	1xØ32									
Air consumption per cycle at 5 bar and nominal stroke [NI]:		0,3	0,07	0,10	0,15	0,23	0,30	0,27	0,53	0,80
Weight [kg]:		0,32	0,40	0,48	0,75	1,00	1,25	1,20	1,73	2,35
Point of application of force for all torques [mm]:	M	71,0	101,0	131,0	102,0	143,5	173,5	119,0	190,0	250,0
Maximum static torques [Nm]:	Ma	13,6	13,6	13,6	19,2	64,0	64,0	40,0	96,0	96,0
	Mb	13,6	13,6	13,6	20,8	64,0	64,0	32,00	88,0	88,0
	Mc	13,6	13,6	13,6	21,6	23,2	23,2	56,0	64,0	64,0
Front stop range of adjustment [mm]:	x2	0-30	0-60	0-90	0-60	0-90	0-120	0-60	0-120	0-180
Rear stop range of adjustment [mm]:	x1	0-30	0-45	0-45	0-60	0-60	0-60	0-60	0-60	0-60
Repeat accuracy [mm]:		±0,01	±0,01	±0,01	±0,01	±0,01	±0,01	±0,01	±0,01	±0,01

Torques

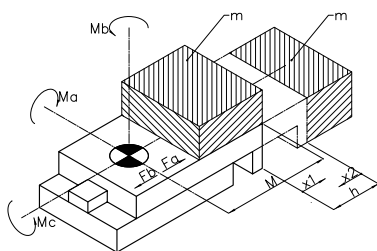

Linear Modules

Load Diagrams

Axial Load

The graph shows the deflection f of the slide under the effect of the force F . The deflection is independent of the stroke.

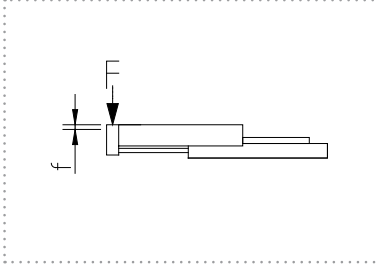

Transverse Load

The graph shows the deflection f of the slide under the effect of the force F . The deflection is independent of the stroke.

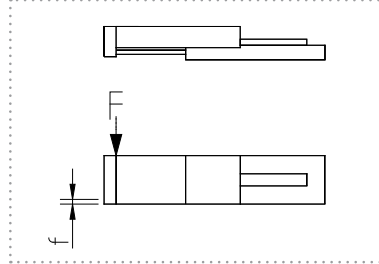

Lateral Load

The graph shows the deflection f of the slide at point A under the effect of the torque. The deflection is independent of the stroke.

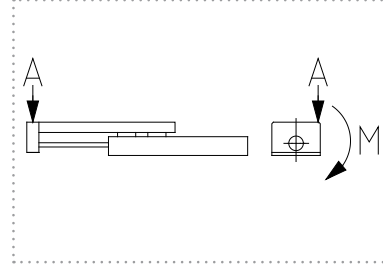

LM 4 F / LM 4 FZ

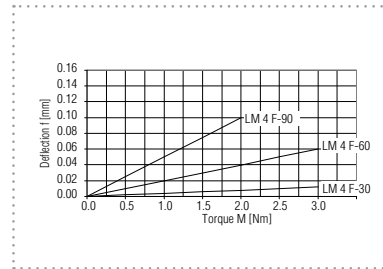
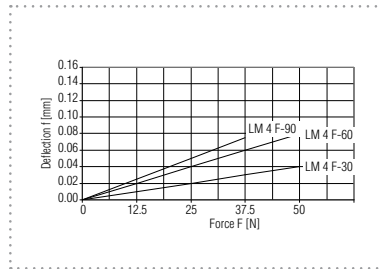
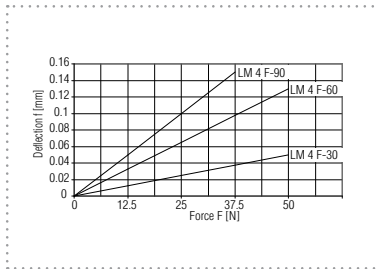

LM 5 F / LM 5 FZ

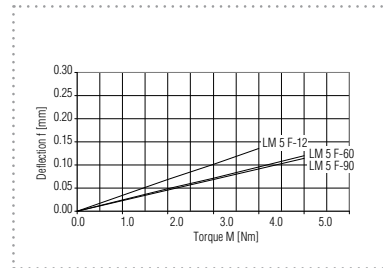
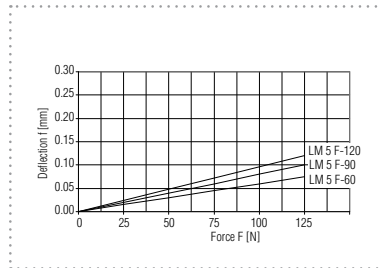
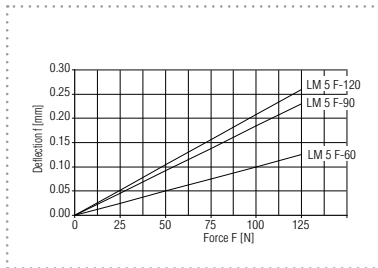

LM 6 F / LM 6 FZ

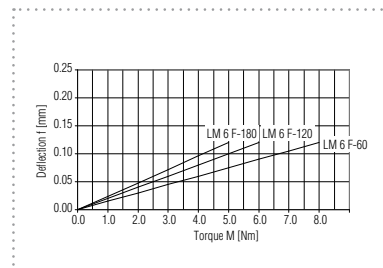
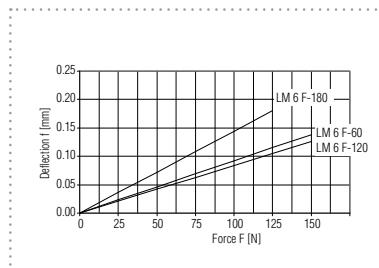
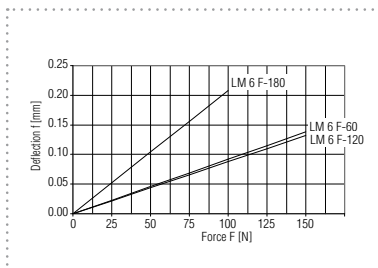

Linear Modules

LM 4 F – Pneumatic Linear Module

LM 4F

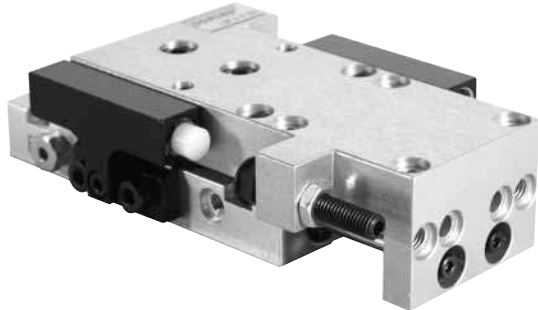

Technical data, stroke-independent

Cylinder diameter	2 x Ø8 mm	
Theor. force (at 5 bar)	Fa	50 N
	Fb	38 N
Max. speed	0,5 m/s	
Pneumatic connections	M5	
Medium	Compressed-air filtered, oiled or non-oiled	
Operating pressure range	3 to 7 bar	
Temperature range	0 to +60°C	
Repeat accuracy	+/-0.01 mm	
Max. permissible mass	0,8 kg	
Max. static torques	Ma	13,6 Nm
	Mb	13,6 Nm
	Mc	13,6 Nm

Technical data, stroke-dependent

See page 44

Permissible travel time t relative to the stroke length and the additional mass m

The travel time t determined from the diagram may not be undershot.

Recommendation: When selecting the module, the travel time t should be assumed as being 20% more.

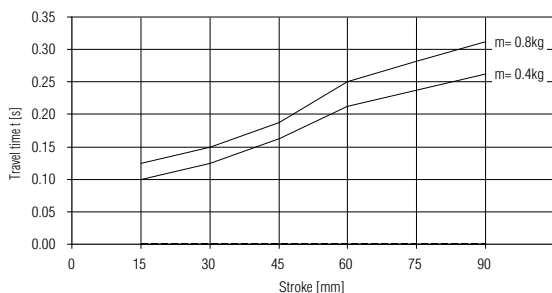

Permissible travel time t = travel time without valve switching time, at nominal pressure 6 bar.

Linear Modules

LM 4 F – Pneumatic Linear Module

Dimensional drawing and pneumatic diagram

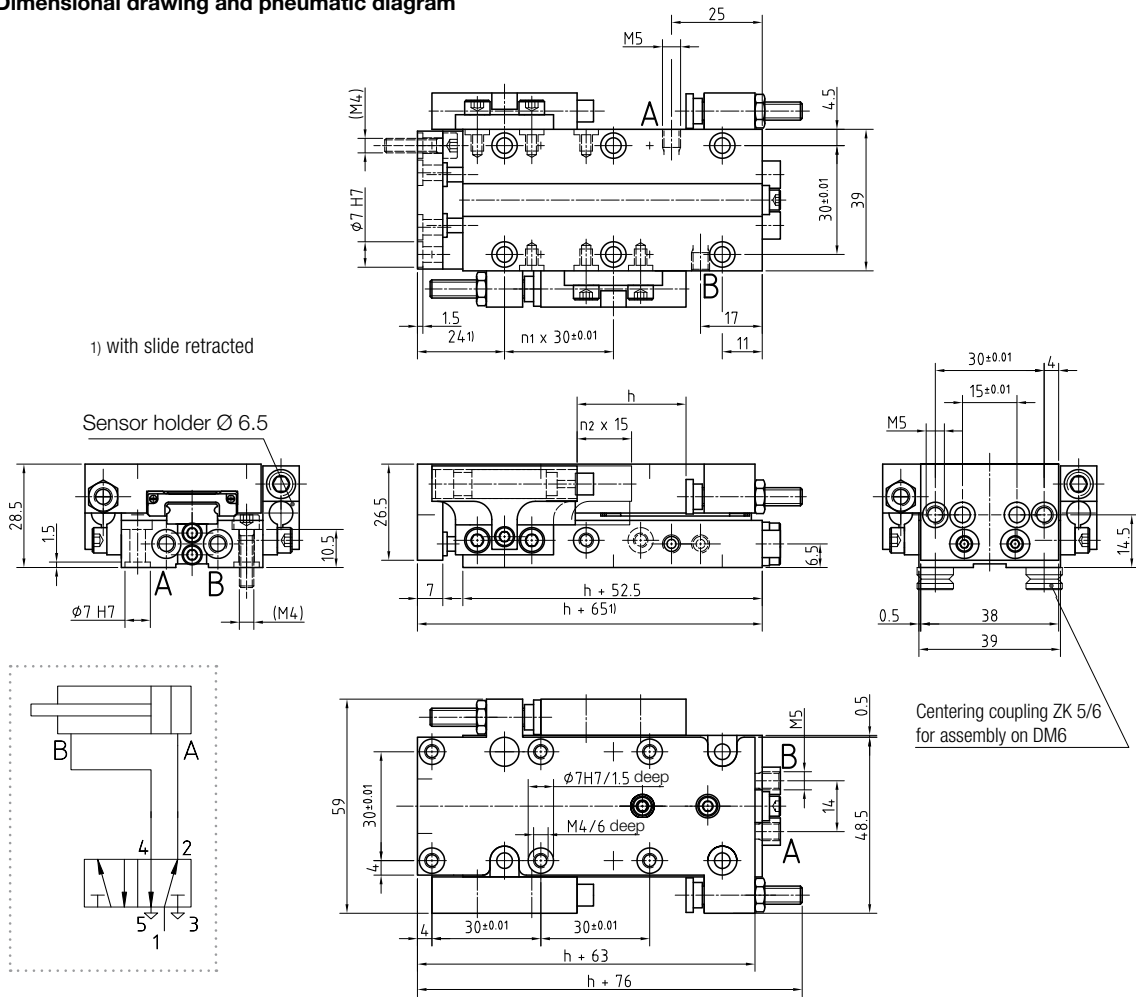

Designation	h	n1	n2
LM 4 F-30	30	2	1
LM 4 F-60	60	3	3
LM 4 F-90	90	4	5

Designation	Order number	Designation	Order number
LM 4 F-030	300 5156	LM 4 F-030 ED	300 5157
LM 4 F-060	300 5159	LM 4 F-060 ED	300 5160
LM 4 F-090	300 5162	LM 4 F-090 ED	300 5163

Incl. hydraulic shock absorber and 4 centering rings Ø7.

Incl. elastomer damper and 4 centering rings Ø7.

Accessories	Order number
Centering ring Ø7	300 1521
Limit switch Ø6,5	300 1845
Centering coupling ZK 5/6	300 2478
Shock absorber	300 1386

See chapter Accessories

Overview

Linear Axes
pneum. / electr.

Linear Modules
pneum. / electr.

Linear Modules
with Intermediate
Positions

Rotary Modules

Grippers

Basic Elements

Accessories